

WHEN DISASSEMBLING ALUMINUM EXTRUSION, TIGHTEN ALL SETSCREWS AND LOCKS TO PREVENT LOSS DURING SHIPPING

visionary™ IDESIGNS

Using Your Setup Instructions

The Visionary Designs Setup Instructions are created specifically for your configuration. They are laid out sequentially, including an exploded view of the entire display, and then a logical series of detailed steps to assemble the main structure and components. We encourage you to study the instructions **before** attempting to assemble your exhibit.

Each page reminds you to tighten the setscrews after disassembling your exhibit to prevent loss of the locks and setscrews (see below in RED). This is **VERY IMPORTANT**.

Cleaning and Packing Your Display

- 1) Use care when cleaning aluminum extrusion or acrylic inserts. Use only non-abrasive cleaners.
- 2) When cleaning laminate inserts or countertops, use mild cleansers and a soft material such as cotton.
- 3) Keep all display components away from extreme heat and long exposure to sunlight to avoid warping and fading.
- 4) Retain all packing material. It will make re-packing much easier and will reduce the likelihood of shipping damage.



The Tool

Most Visionary Designs exhibits can be assembled with the supplied Hex Key Tool. Occasionally, a flat head screwdriver may be required.



Typical Connection



Typical Connection (cont'd)

Most horizontal extrusion connections have a patented expandable lock. This lock inserts into the groove of an opposing extrusion. Tightening the lock with the Hex Key Tool expands the lock and creates a strong positive connection.

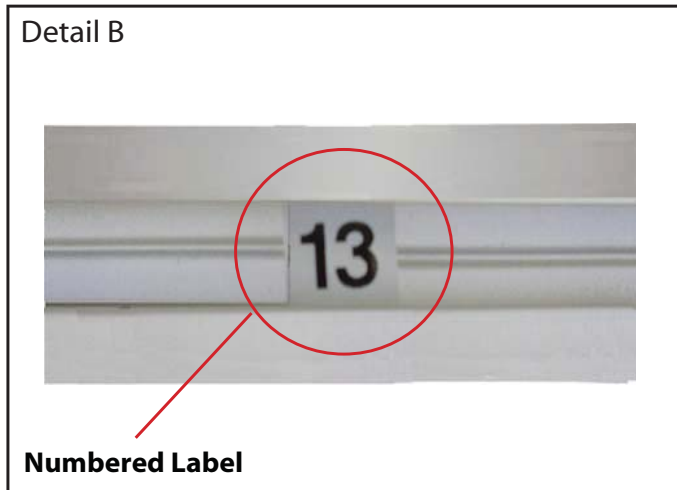

Detail B

Numbered Label

Each extrusion contains a numbered label which corresponds with setup instructions. The label is located within a groove of the extrusion (when possible). With Visionary Designs the labels contain Black numbers unless otherwise specified.



Detail C

Horizontal Inline Connection (remove only one setscrew)

Remove only (1) setscrew when disassembling. Replace setscrew in extrusion after assembling it. Before packing, replace setscrew in extrusion to avoid losing it.

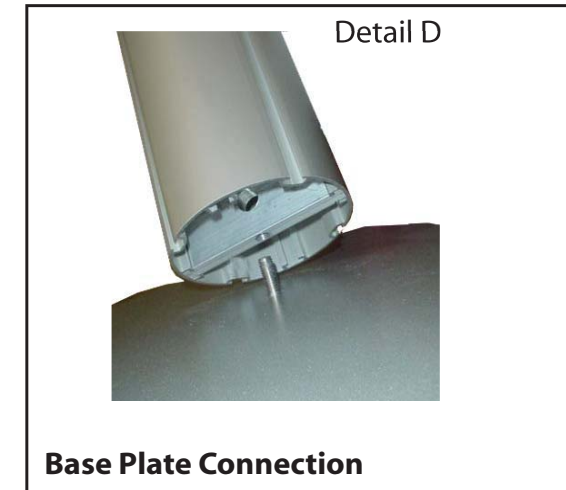

Detail D

Base Plate Connection

Attach base plate to round or square vertical extrusion using the bolt provided. Be careful not to strip the threads.

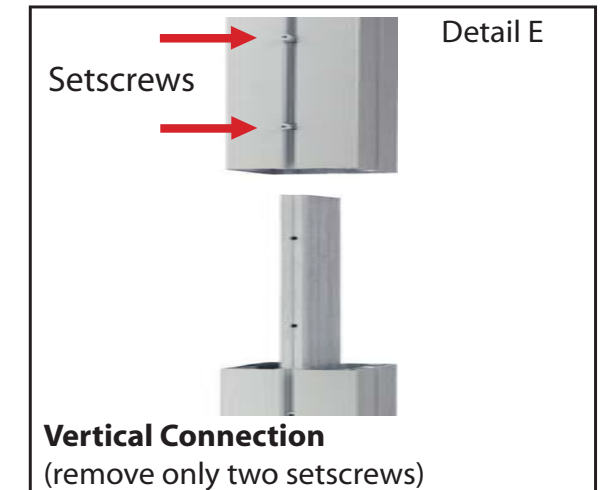

Detail E

Vertical Connection
(remove only two setscrews)

When vertical extrusions are packed in portable cases rather than crates or tubs, they must be broken down into smaller sections which then require assembly.

Remove only (2) setscrews when disassembling. Replace setscrews in extrusion after assembling it. Before packing, replace setscrews in extrusion to avoid losing them.

WHEN DISASSEMBLING ALUMINUM EXTRUSION, TIGHTEN ALL SETSCREWS AND LOCKS TO PREVENT LOSS DURING SHIPPING

866.652.2100

Item	Qty.	Description
1	2	Base Plate
2	1	42" h Lower Square Vertical Extrusion
3	1	42" h Upper Square Vertical Extrusion
2a	1	42" h Lower Square Vertical Extrusion w/ A10 Clamps Attached
3a	1	42" h Upper Square Vertical Extrusion w/ A10 Clamps Attached
4a/4b	1/1	45" w Horizontal Extrusion
5a/5b	1/1	45" w Horizontal Extrusion

- Steps:
- 1) Attach vertical extrusions [2] to base plates [1].
 - 2) Attach upper vertical extrusions [3a and 3] to lower extrusions [2a and 2] using connection bar [a].
 - 3) Connect horizontal extrusions [4a to 4b and 5a to 5b] together using connection bar [b].
 - 4) Attach horizontal assemblies [4a/4b and 5a/5b] between vertical assemblies as shown.
 - 5) Apply graphic to back of assembled backwall.
 - 6) Attach light to top of assembled backwall.

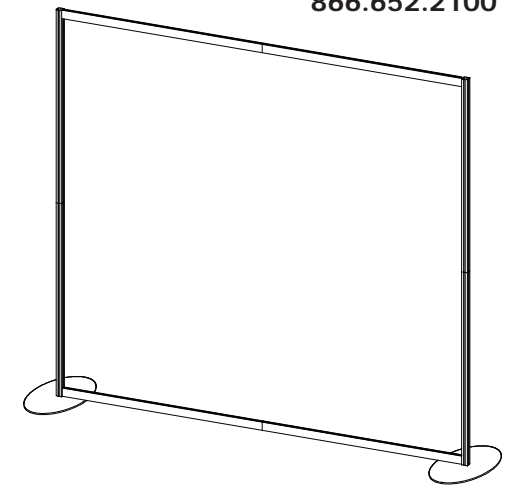

STAR indicates location of knobs on BACKSIDE of unit.

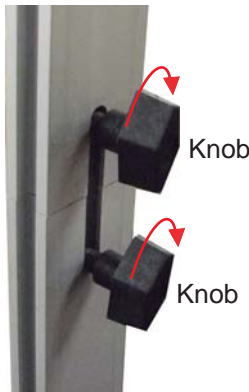

Turn Knob Clockwise to Tighten Lock

****Do not over tighten Knobs.****

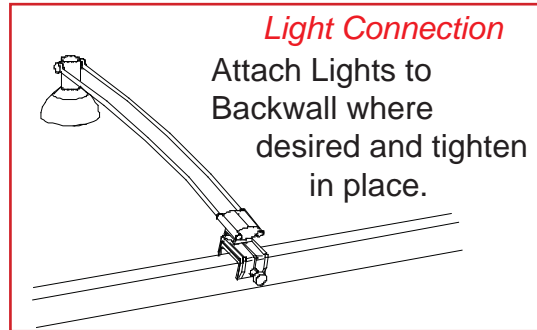

Light Connection

Attach Lights to Backwall where desired and tighten in place.

GREEN STAR indicates location of connection lock with knob.

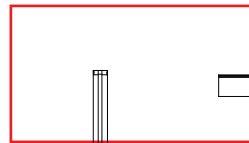
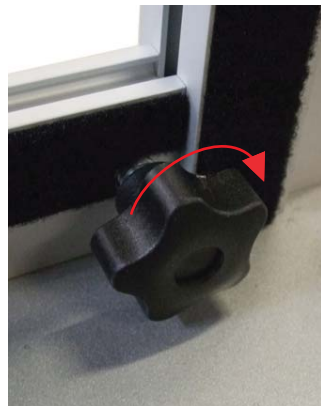

A10 clamps attached to vertical extrusions for Wing Attachment

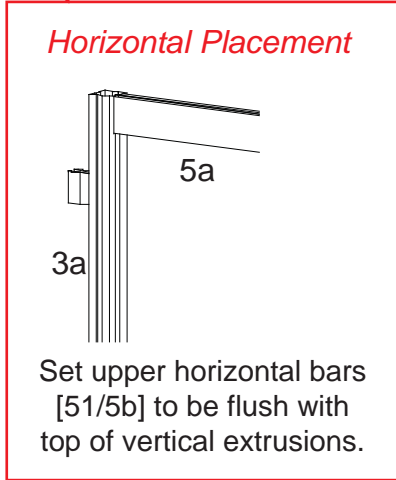

Horizontal Placement

Set upper horizontal bars [5a/5b] to be flush with top of vertical extrusions.

Graphic Attachment
Apply graphic to back of assembled backwall.

Slide Connection Bar between Extrusions and tighten Knobs to secure.

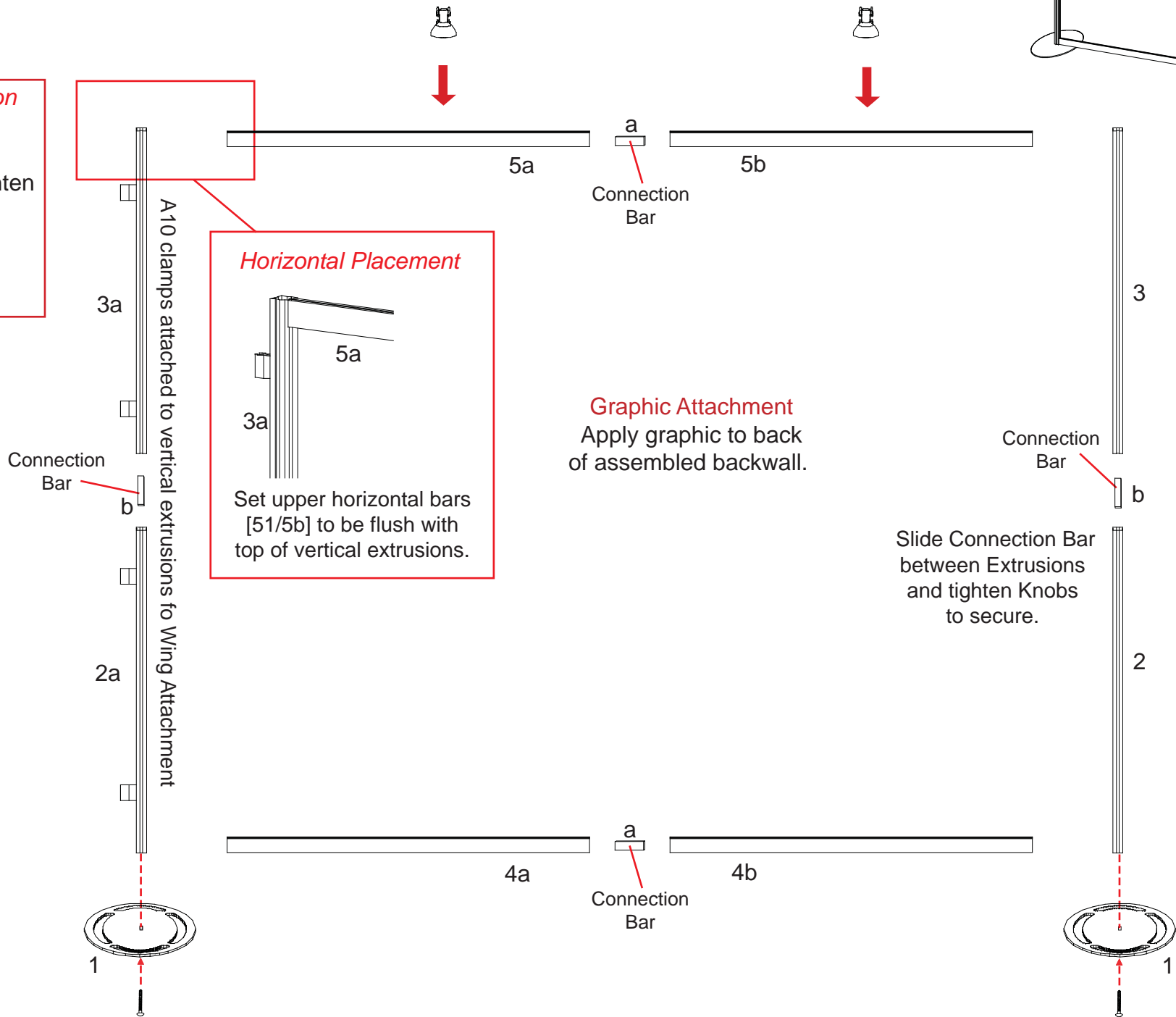

WHEN DISASSEMBLING ALUMINUM EXTRUSION, TIGHTEN ALL SETSCREWS AND LOCKS TO PREVENT LOSS DURING SHIPPING

866.652.2100

Item	Qty.	Description
1	2	Base Plate
4a/4b	1/1	45" w Horizontal Extrusion
5a/5b	1/1	45" w Horizontal Extrusion
7	1	42" h Lower Square Vertical Extrusion
8	1	42" h Upper Square Vertical Extrusion
7a	1	42" h Lower Square Vertical Extrusion w/ A10 Clamps Attached
8a	1	42" h Upper Square Vertical Extrusion w/ A10 Clamps Attached
9	1	24" w Horizontal Extrusion
10	1	24" w Horizontal Extrusion

Steps:

- 1) Attach vertical extrusions [7 and 7a] to base plates [1].
- 2) Attach upper vertical extrusions [8 and 8a] to lower extrusions [7 and 7a] using connection bar [b].
- 3) Connect horizontal extrusions [4a to 4b and 5a to 5b] together using connection bar [a].
- 4) Attach horizontal assemblies [4a/4b and 5a/5b] between vertical assemblies as shown.
- 5) Apply graphic to back of assembled backwall.
- 6) Attach light to top of assembled backwall.

STAR indicates location of knobs on BACKSIDE of unit.

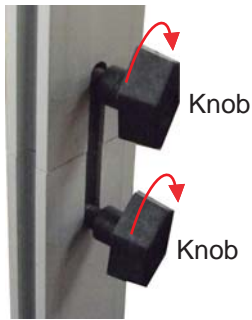

Turn Knob Clockwise to Tighten Lock

Do not over tighten Knobs.

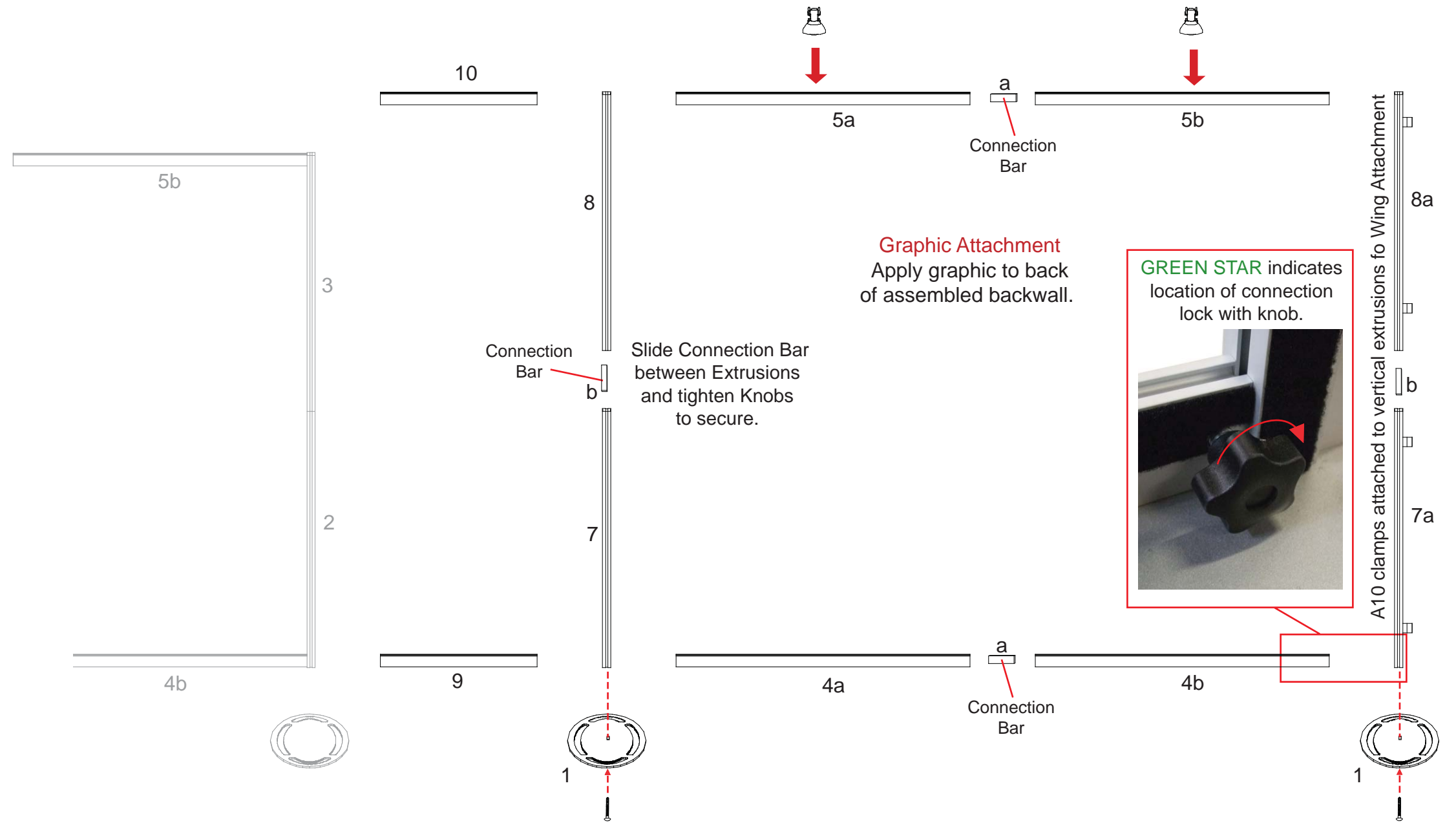
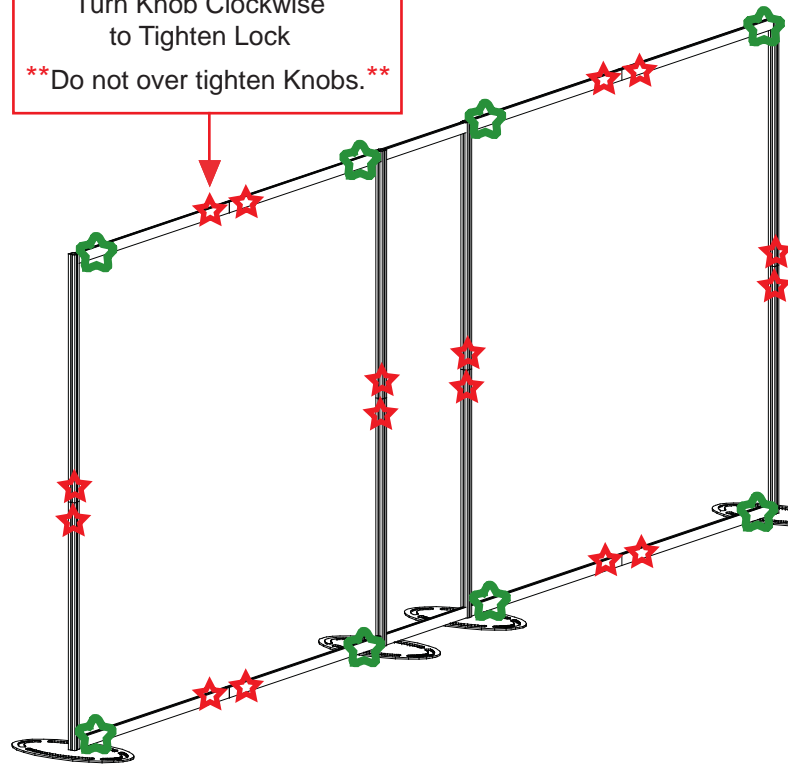

Graphic Attachment
Apply graphic to back of assembled backwall.

GREEN STAR indicates location of connection lock with knob.



A10 clamps attached to vertical extrusions for Wing Attachment

WHEN DISASSEMBLING ALUMINUM EXTRUSION, TIGHTEN ALL SETSCREWS AND LOCKS TO PREVENT LOSS DURING SHIPPING

Item	Qty.	Description
14	2	30.2" Curved Extrusion
15	2	12.184"w Horizontal Extrusion
15a	2	Flange Plate

Steps:

- 1) Connect horizontal extrusion [15] to curved extrusion [14].
- 2) attach assembled counter support [14/15] to vertical where indicated.
- 3) Attach flange plate [15a] to top of curved extrusion [14] as shown.
- 4) Attach counter atop support, see counter top attachment detail.
- 5) Repeat steps for additional counter.
- 6) Attach monitor mounts to assembled backwall, see attachment details below.
- 7) Attach wings to A10 clamps.

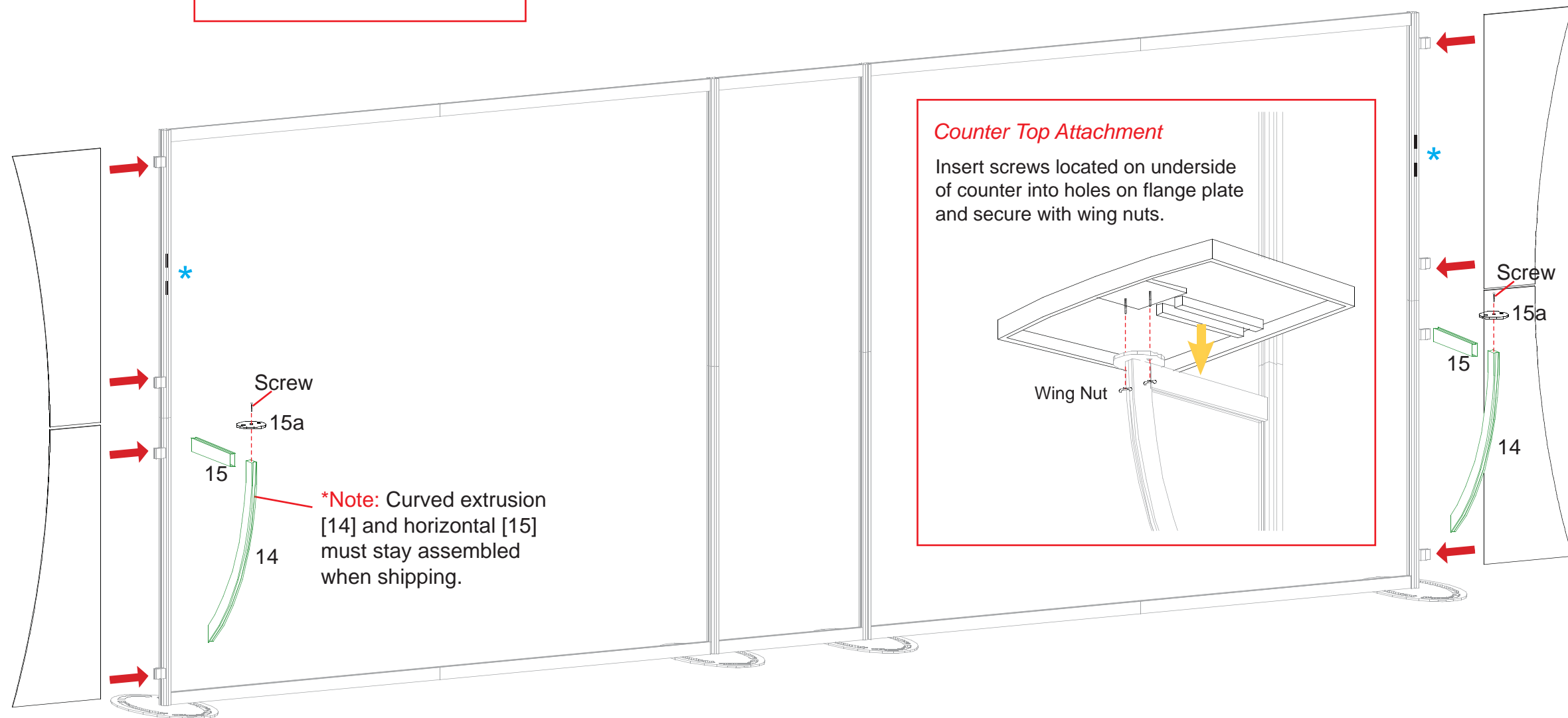
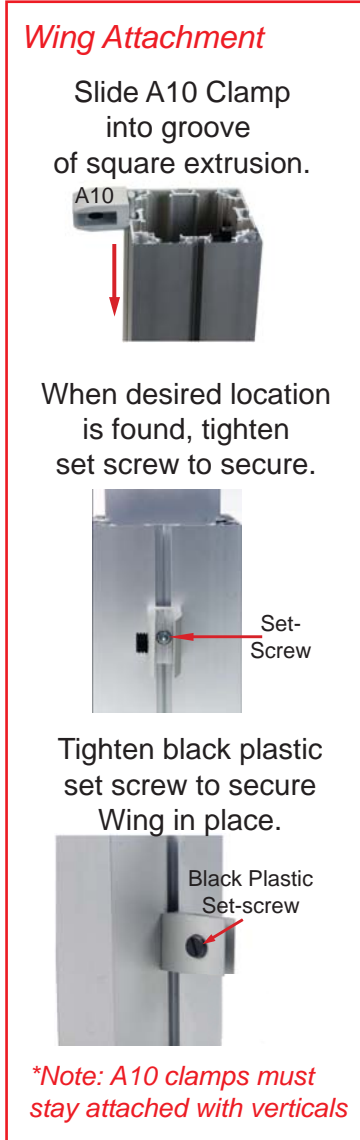
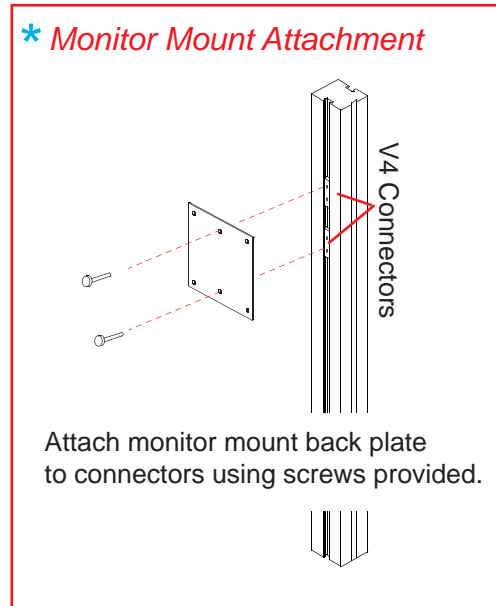

WHEN DISASSEMBLING ALUMINUM EXTRUSION, TIGHTEN ALL SETSCREWS AND LOCKS TO PREVENT LOSS DURING SHIPPING



Steps:

- 1) Connect canopy pieces together as shown.
- 2) Apply pillow case graphic to assembled canopy

Using Your Setup Instructions

The Aero Overhead Sign Setup Instructions are created specifically for your configuration. They include an exploded view of the frame which is sequentially numbered. We encourage you to study the instructions before attempting to assemble your exhibit.

Connections are kept very simple: no tools. Everything assembles with push-button connectors and pre-connected horizontal sections.

Cleaning and Packing Your Display

- 1) Use care when cleaning aluminum extrusion or acrylic inserts. Use only non-abrasive cleaners.
- 2) Retain all packing material. It will make re-packing much easier and will reduce the likelihood of shipping damage.

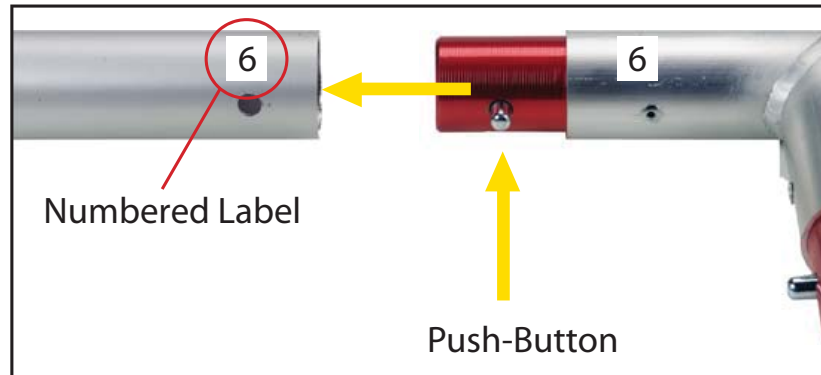
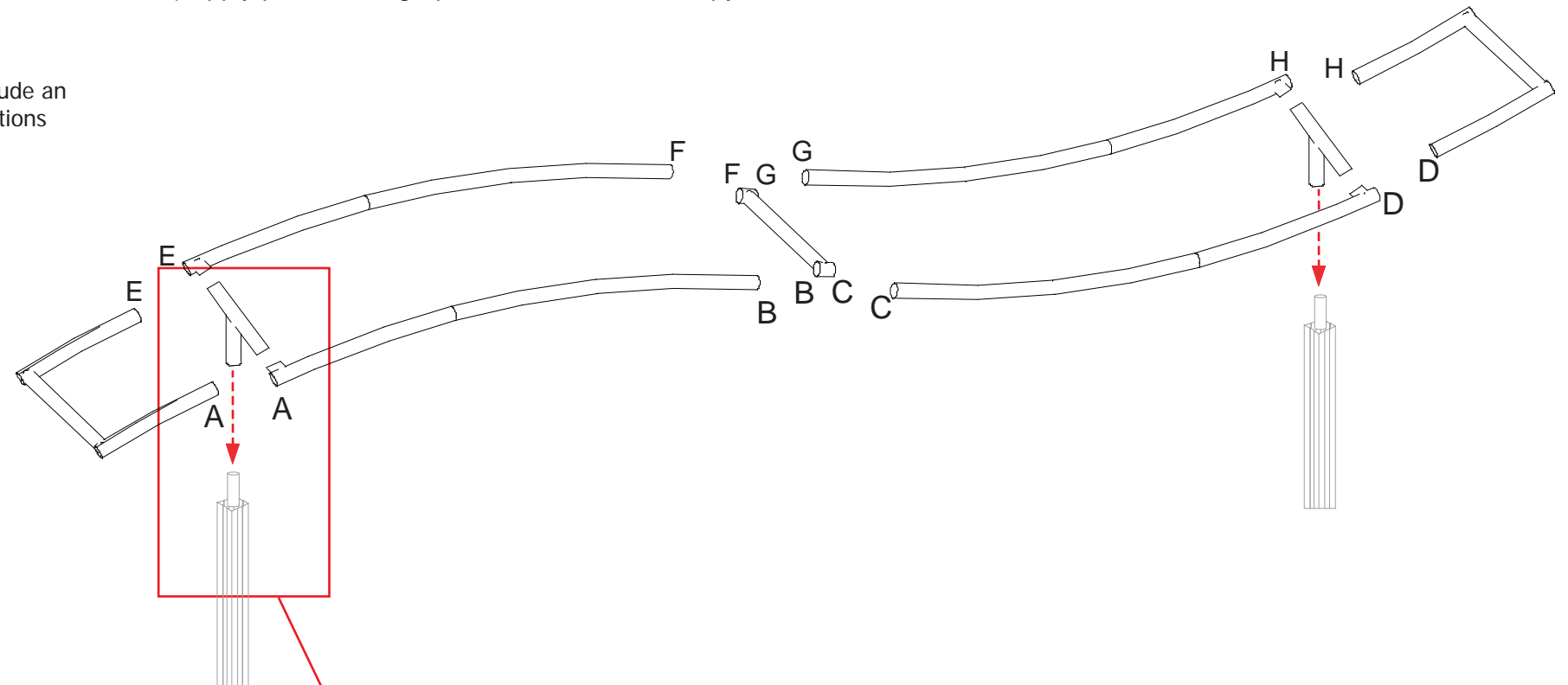

Connections are made by holding the button down and sliding the red tube into opposing tube until the connection is made. To disassemble push button and pull or twist extrusions apart.

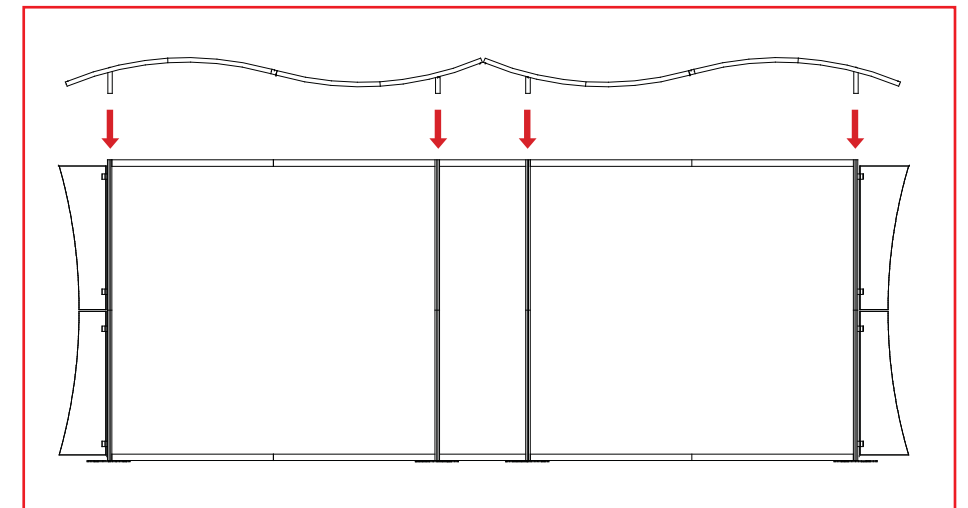
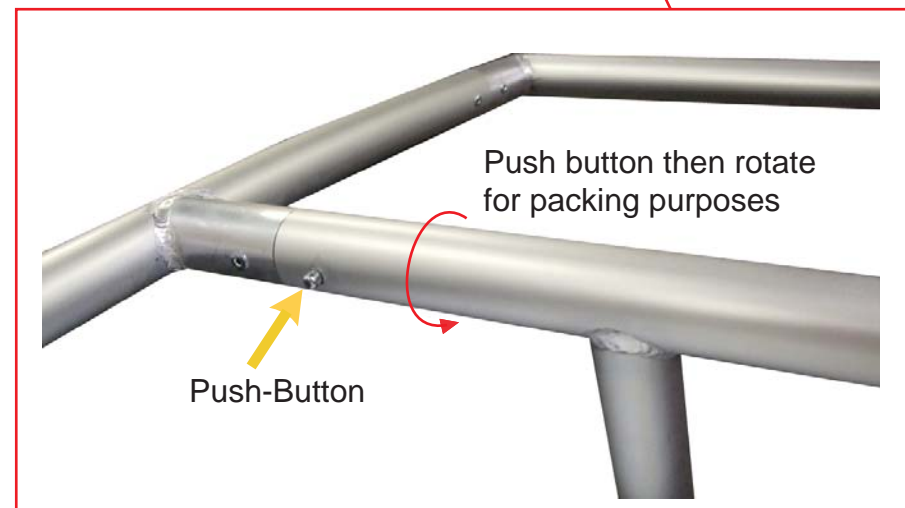
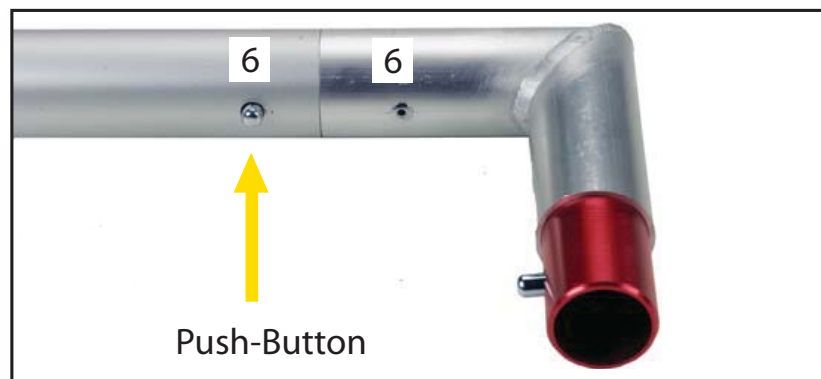

WHEN DISASSEMBLING ALUMINUM EXTRUSION, TIGHTEN ALL SETSCREWS AND LOCKS TO PREVENT LOSS DURING SHIPPING

Part Number	Qty	Description
16	4	38" Vertical Extrusion
17/17a	2/2	12" Horizontal Extrusion
18	2	25" Horizontal Extrusion

Steps

- 1) Attach horizontal extrusions [17 and 17a] between vertical extrusions [16], placing inserts between horizontals.
- 2) Attach curved horizontal extrusions [18] between vertical extrusions [16], placing insert between curved horizontals.

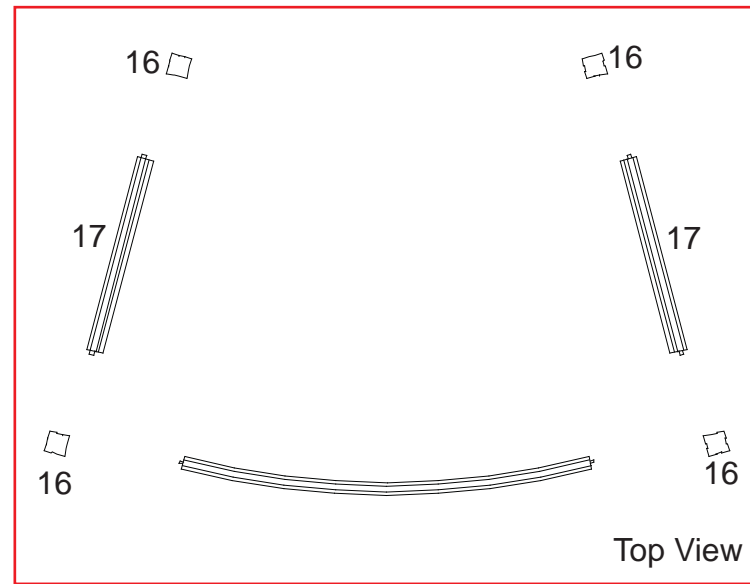

Steps (Cont'd):

- 3) Place shelf atop lip of extrusions.
- 4) Set counter top atop assembled base.

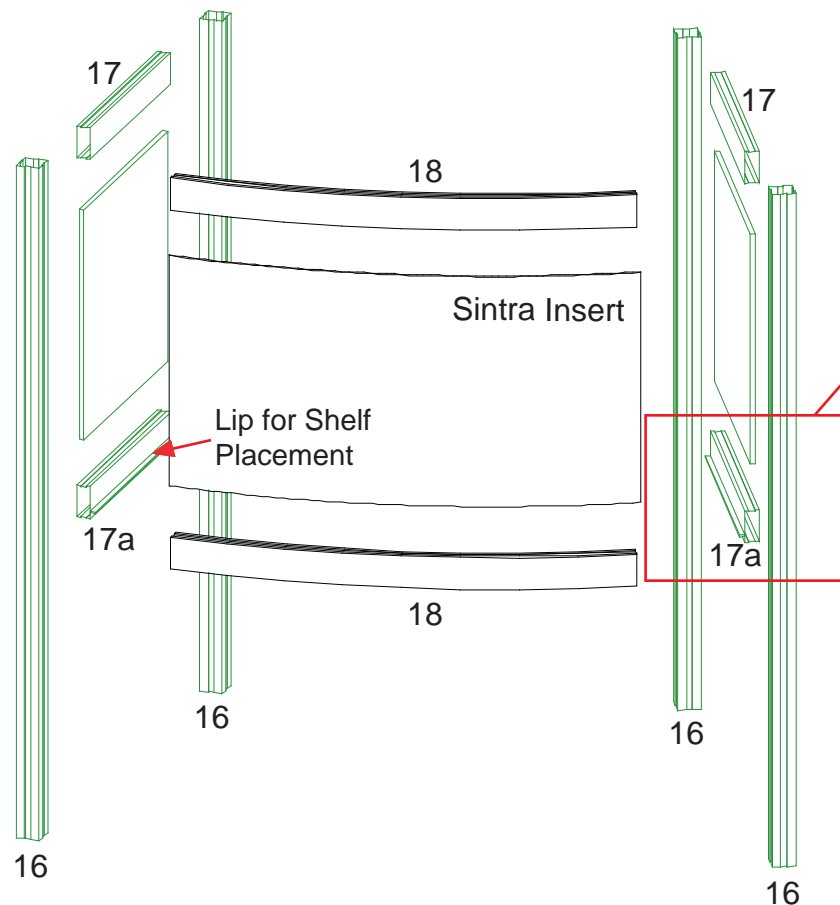
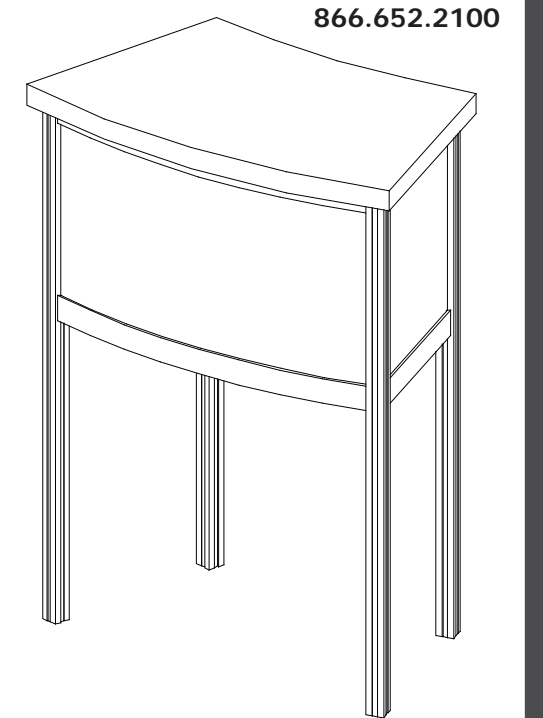

Extrusion Details:
Extrusions 17a have a lip for the floor to rest upon.

***Note:** Pedestal sides must stay assembled when shipping

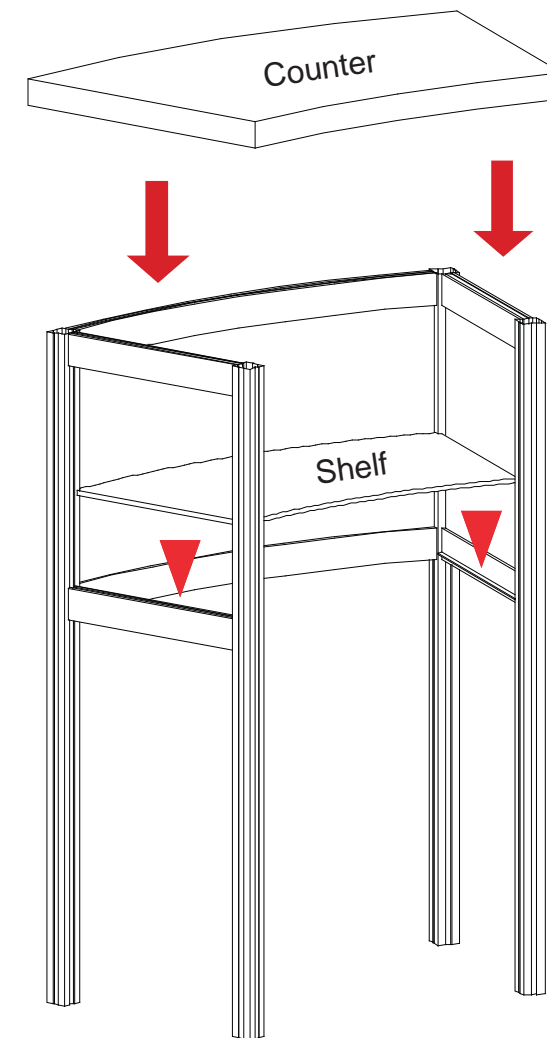

WHEN DISASSEMBLING ALUMINUM EXTRUSION, TIGHTEN ALL SETSCREWS AND LOCKS TO PREVENT LOSS DURING SHIPPING

(1) Backwall Components

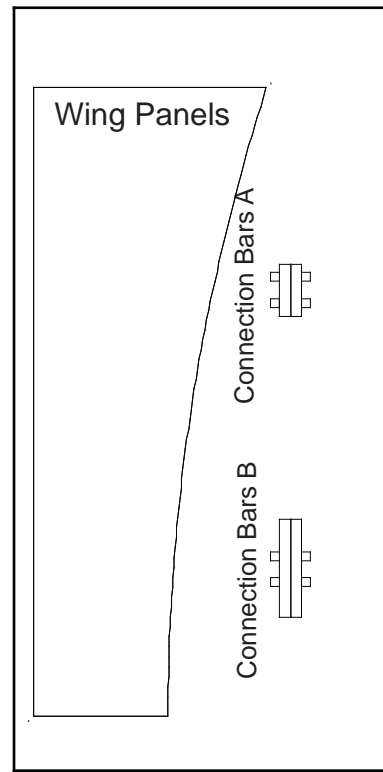

Level 1

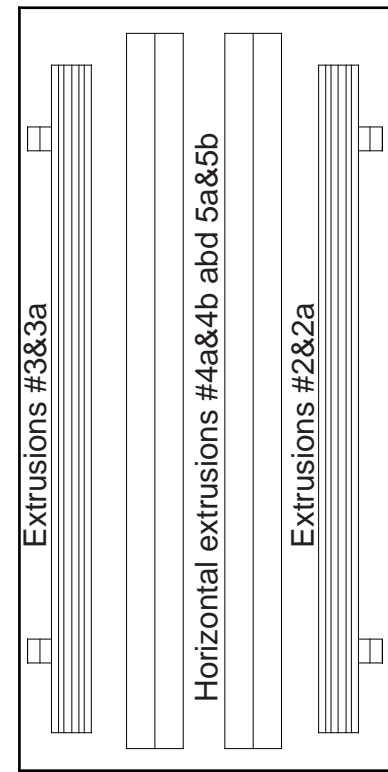

Level 2

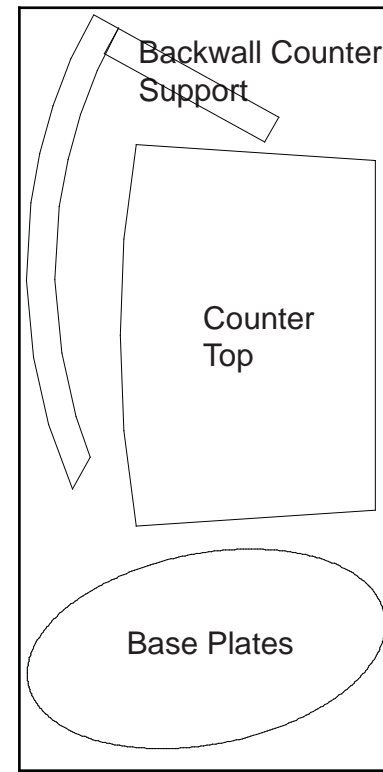

Level 3

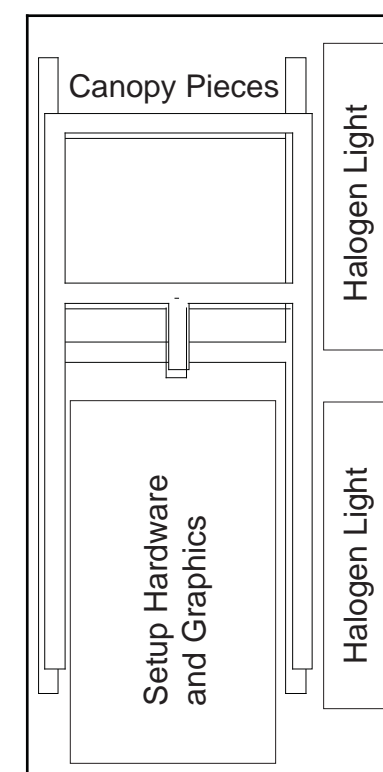

Slip Sheet

WHEN DISASSEMBLING ALUMINUM EXTRUSION, TIGHTEN ALL SETSCREWS AND LOCKS TO PREVENT LOSS DURING SHIPPING

(2) Backwall Components

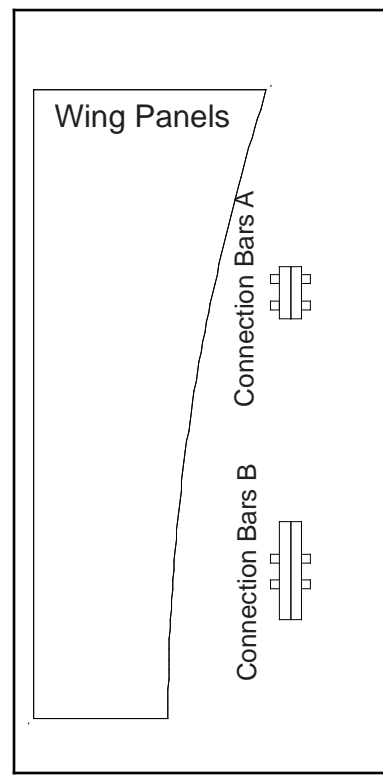

Level 1

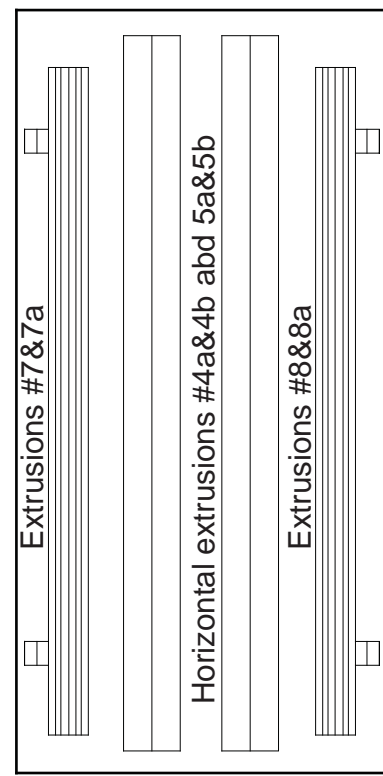

Level 2

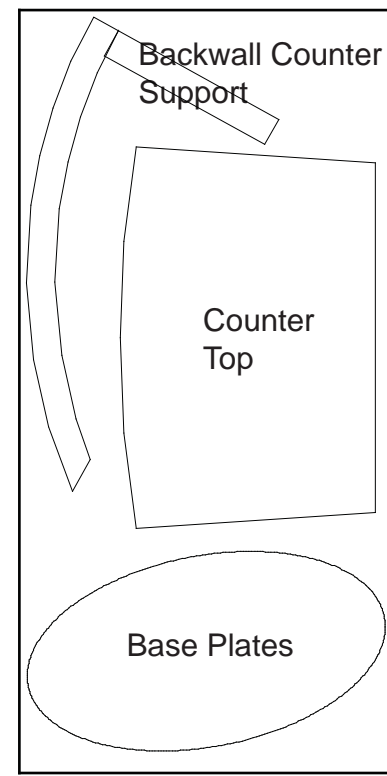

Level 3

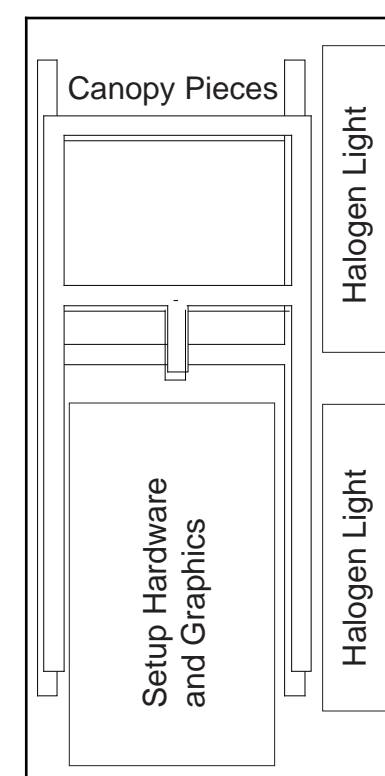

Slip Sheet

WHEN DISASSEMBLING ALUMINUM EXTRUSION, TIGHTEN ALL SETSCREWS AND LOCKS TO PREVENT LOSS DURING SHIPPING

(3) Pedestal Components

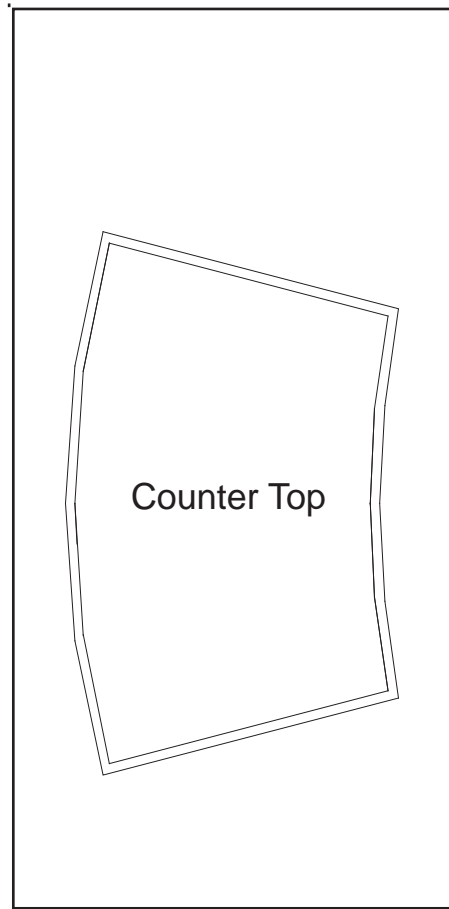

Level 1

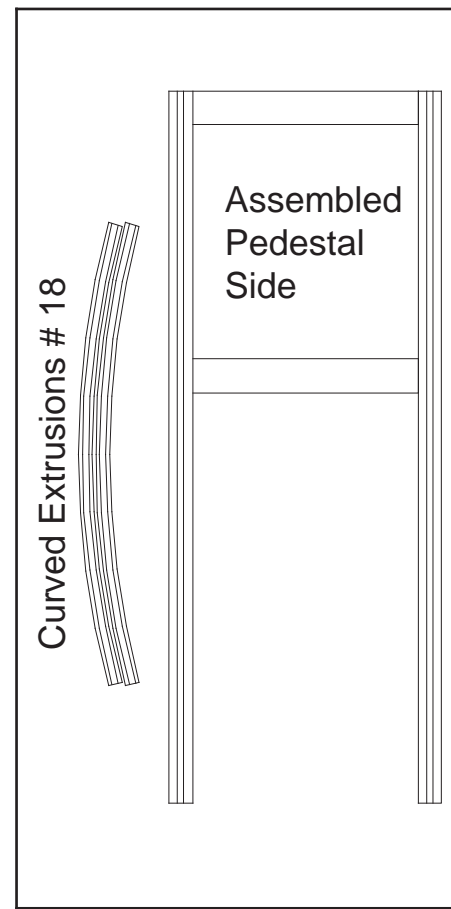

Level 2

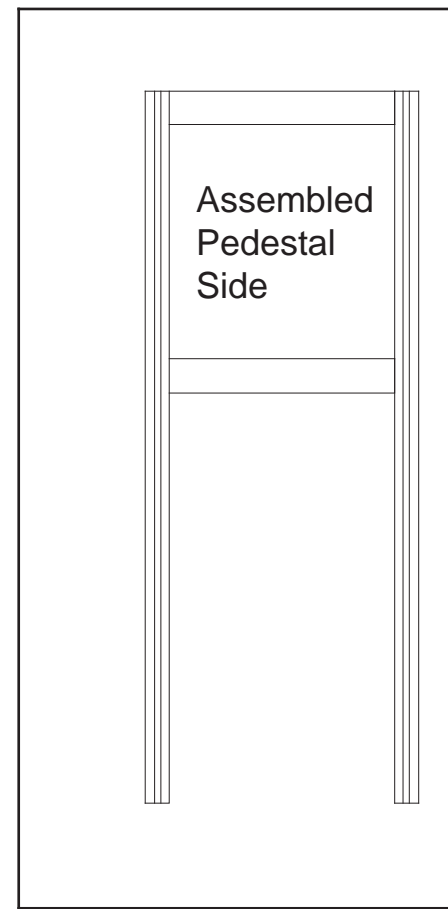

Level 3

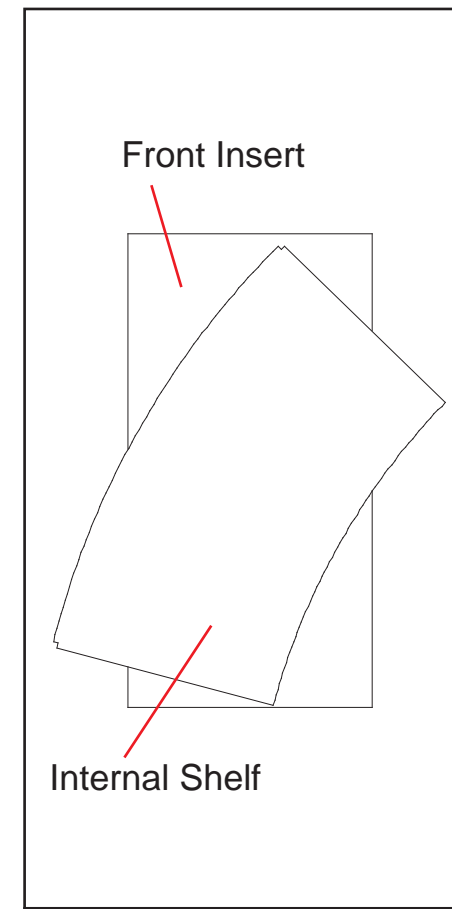

Level 4

WHEN DISASSEMBLING ALUMINUM EXTRUSION, TIGHTEN ALL SETSCREWS AND LOCKS TO PREVENT LOSS DURING SHIPPING

(4) Pedestal Components

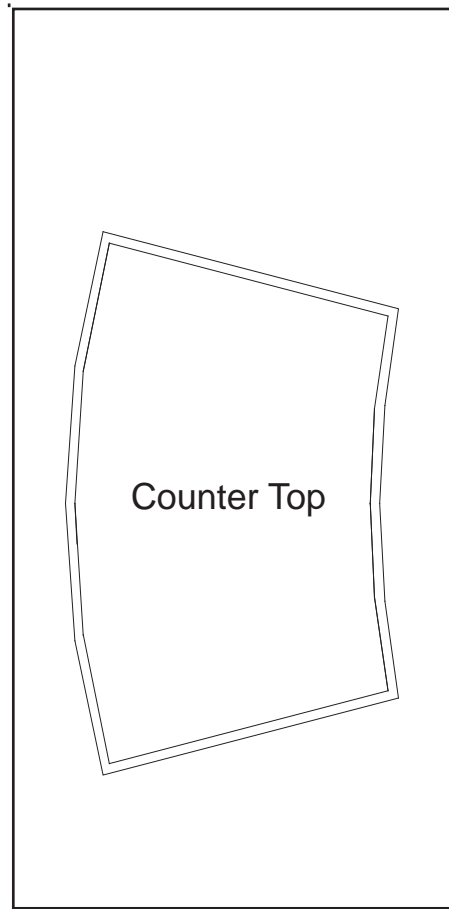

Level 1

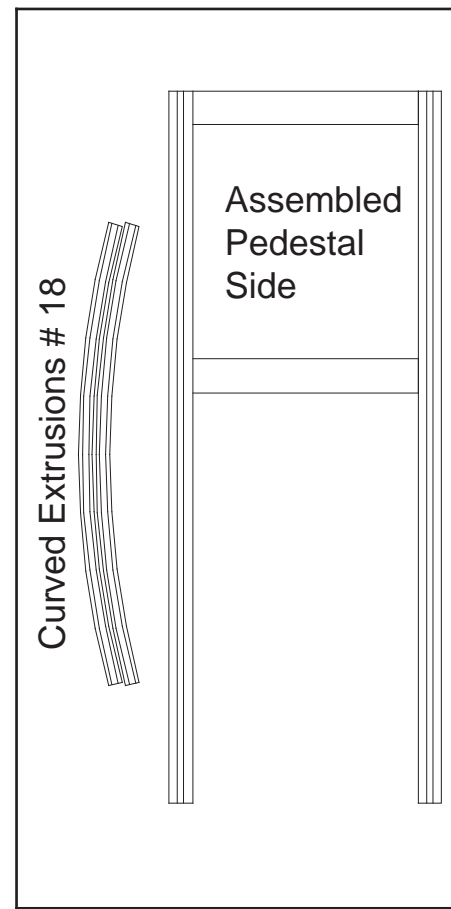

Level 2

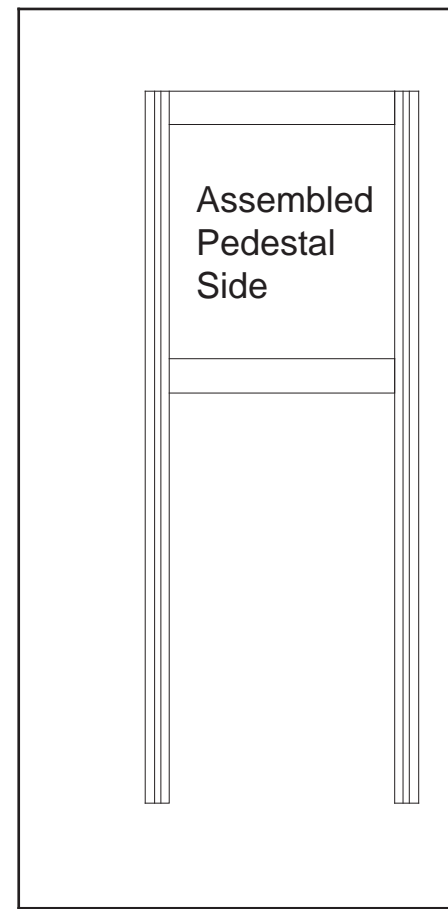

Level 3

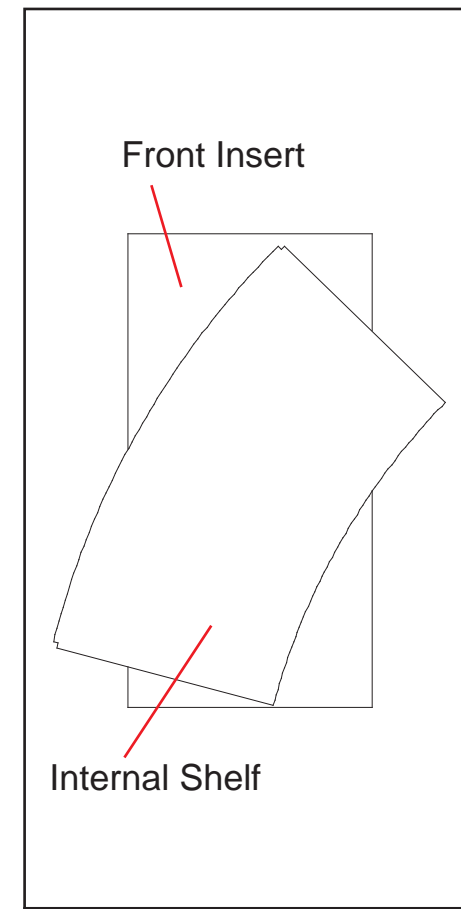

Level 4

WHEN DISASSEMBLING ALUMINUM EXTRUSION, TIGHTEN ALL SETSCREWS AND LOCKS TO PREVENT LOSS DURING SHIPPING